

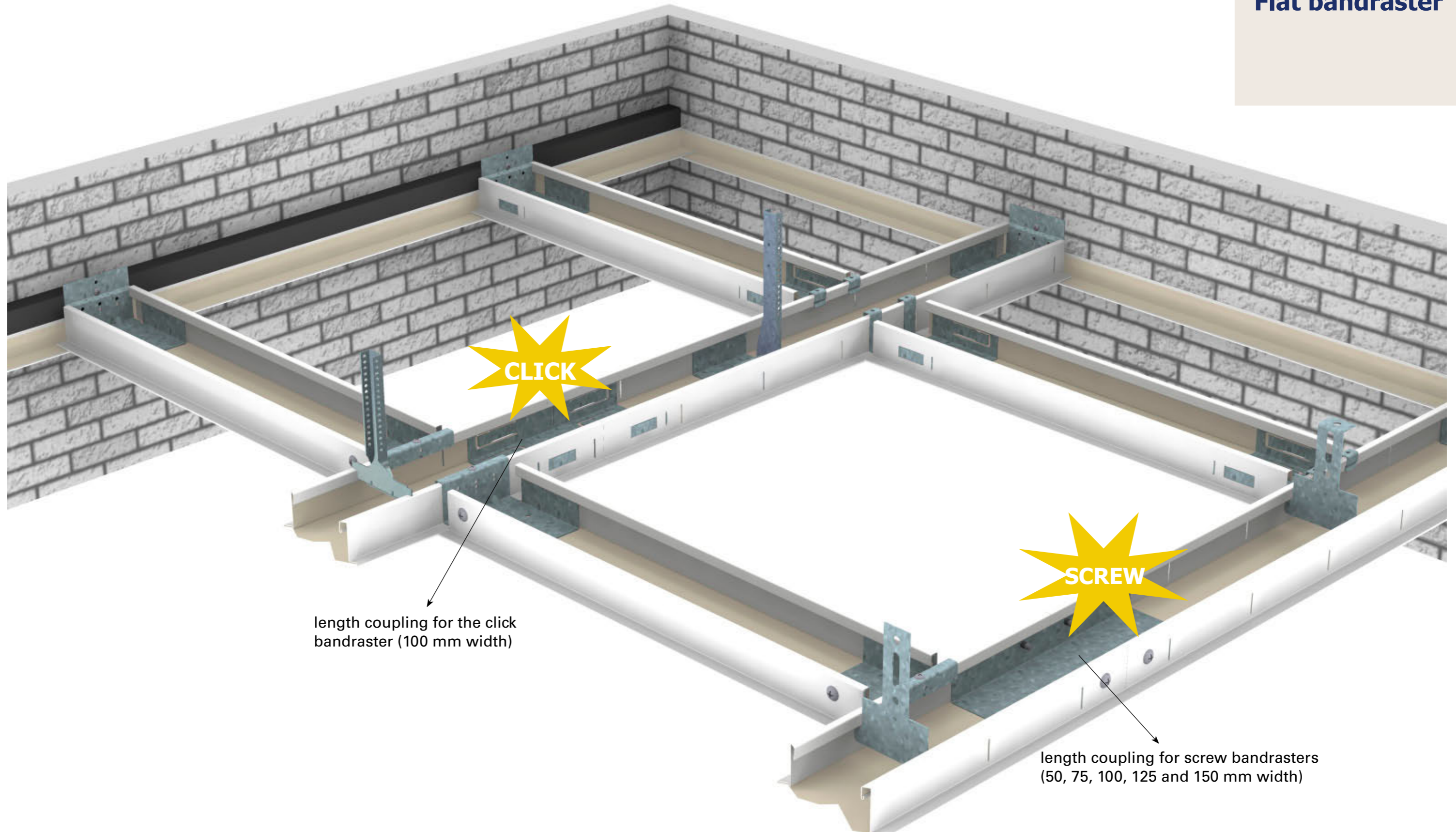

Visible Flat bandraster



CLICK

length coupling for the click bandraster (100 mm width)

SCREW

length coupling for screw bandrasters (50, 75, 100, 125 and 150 mm width)

Profiles

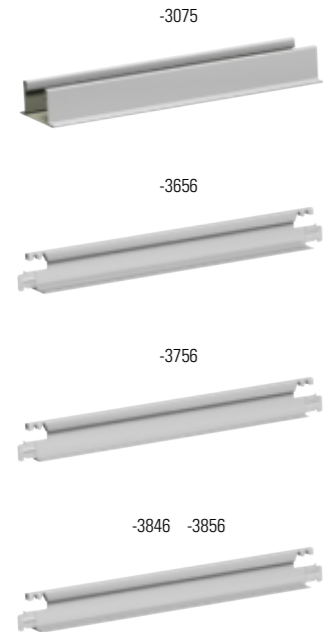

Wall angles

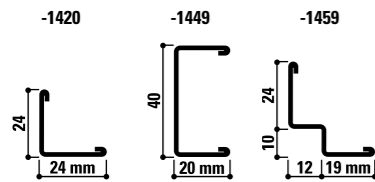

See chapter on wall angles for the complete overview.

PRODUCT	LENGTH	PER CARTON			PER PALLET	
		Reference	mm	pcs.	m	kg

Main runner

-3075 30 001	3600	8	28,8	27,8	35	973
-3075 31 001	3750	8	30	28,9	35	1012

Cross tee for bandraster with a 15, 24 or 35 mm visible side

-3656 99 001	Dimensions: min. 300 - max. 2700
-3756 99 001	Dimensions: min. 300 - max. 2700
-3846 99 001	Dimensions: min. 300 - max. 2700
-3856 99 001	Dimensions: min. 300 - max. 2700

PRODUCT		PER CARTON		
Reference	Product description	Max. load	pcs.	kg

Accessories

-3076	Length coupling for bandraster 3075	-	25	4.63
-3077	Flat hanger for bandraster 3075	40.0	100	2.74
-3078	Cross connector for bandraster 3075	-	25	2.21
-3079	Wall connector for bandraster 3075	-	25	2.24
-3080	Bent hanger for bandraster 3075	40.0	100	2.84
-3236	Lower part nonius hanger for bandraster 3075 and 3475	40.0	100	3.80
10200	Upper part nonius hanger / H = 90 mm	40.0	100	2.40
--88	Wedge clip / H = 23 mm	-	250	2.10
AX087X500P	Wedge clip for metal tiles / H = 40 mm	-	500	4.03
--917	Cross tee pincer for bandraster 3075, 3100, 3125 and 3150	-	1	2.45



- Bandraster -3075 can be combined with many other CMC systems.
- Min. length for bandraster profiles = 600 mm / max. length for bandraster profiles = 6300 mm.
- The min. length for slotted bandrasters = 1100 mm.
- Profiles can easily be provided with extra slots at the job by means of pincer type --917.
- High placed slots are available for the combination with tegular panels.
- The bandraster cross tees are available with special lengths and slot patterns at special request.

Accessories

Length coupling for bandraster 3075
-3076

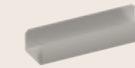

Flat hanger for bandraster 3075
-3077



Cross connector for bandraster 3075
-3078



Wall connector for bandraster 3075
-3079



Bent hanger for bandraster 3075
-3080



Lower part nonius hanger for bandraster 3075 and 3475
-3236



Upper part nonius hanger / H = 90 mm
10200

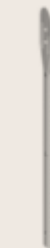

Wedge clip / H = 23 mm
--88



Wedge clip for metal tiles / H = 40 mm
AX087



Cross tee pincer for bandraster 3075, 3100, 3125 and 3150
--917



Visible

Screw bandraster System 3075

- 75 mm wide screw bandraster system.
- Appropriate for acoustical barriers and the installation of removable partitions.
- Reaction to fire: A1 (EN 13501-1).
- Corrosion class: B (EN 13964).

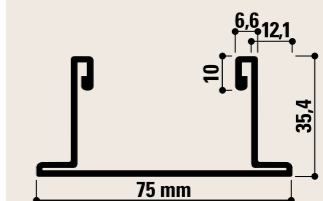
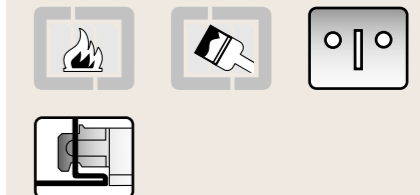

Tiles



Colours and range

System 3075 is supplied in CMC white 001, white 901 and grey 04. Special lengths and slot patterns are available upon request.

